

600mA ULDO REGULATOR WITH ENABLE**AP2318****General Description**

The AP2318 is a series of ultra low dropout regulators optimized for low voltage applications where transient response and minimum input voltage are critical.

The AP2318 provides current limit and thermal shutdown. Its circuit includes a trimmed bandgap reference to assure output voltage accuracy to be within $\pm 1.5\%$. On-chip thermal shutdown provides protection against any combination of overload and ambient temperatures that would create excessive junction temperatures.

The AP2318 has both fixed and adjustable versions. The 1.3V fixed versions integrate the corresponding resistor divider. The adjustable version can set the output voltage through two external resistors.

The AP2318 is available in the standard DFN-3 \times 3-8 and SOIC-8 packages.

Features

- Wide Operating Voltage Ranges: 2.5V to 12V
- Output Voltage Accuracy: $\pm 1.5\%$
- On-chip Thermal Shutdown
- ESD: Human Body Model 3kV
Machine Model 600V
- Operating Junction Temperature: -40°C to 125°C

Applications

- Notebook
- USB Device
- Add-on Card
- DVD Player
- PC Motherboard

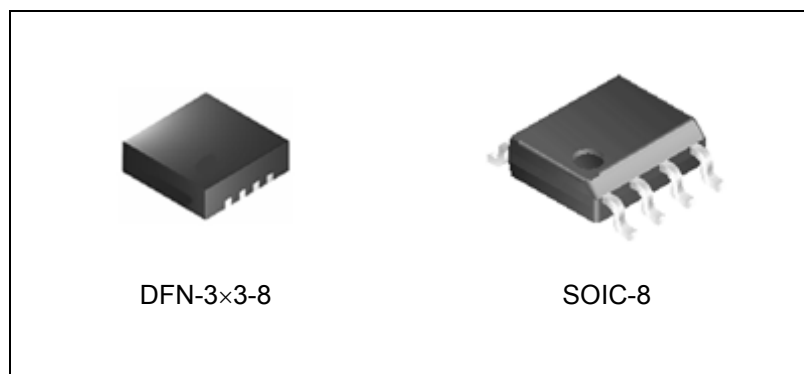

Figure 1. Package Types of AP2318

600mA ULDO REGULATOR WITH ENABLE

AP2318

Pin Configuration

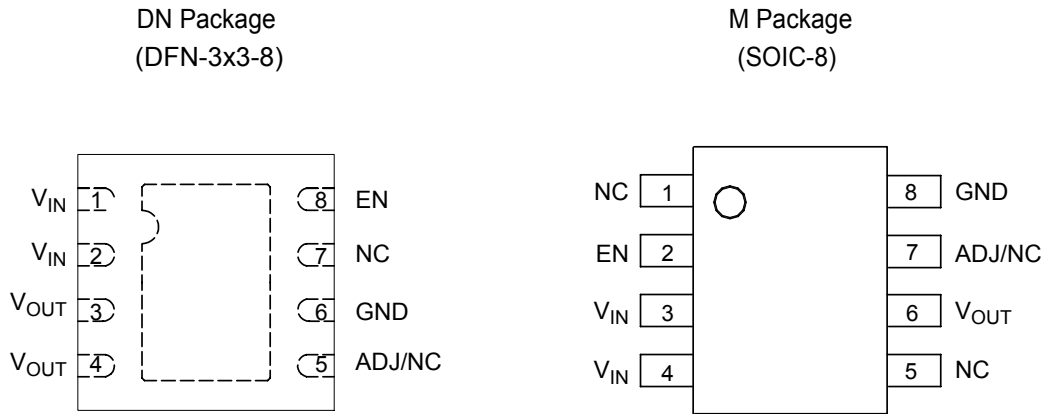

Figure 2. Pin Configuration of AP2318 (Top View)

Functional Block Diagram

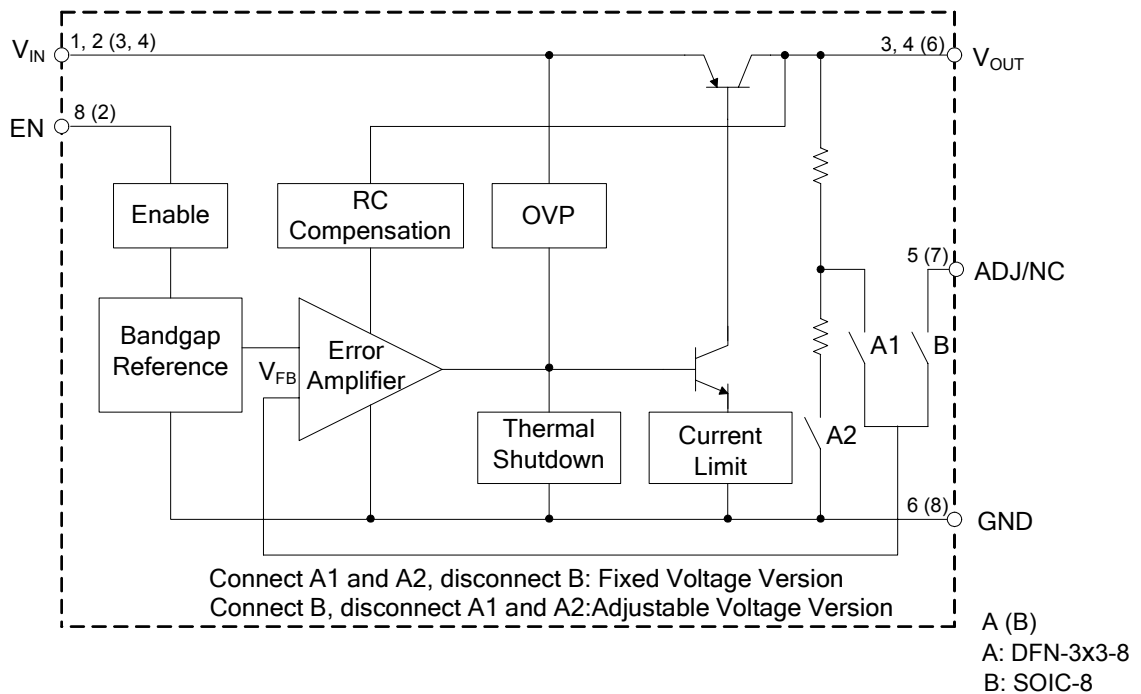

Figure 3. Functional Block Diagram of AP2318



600mA ULDO REGULATOR WITH ENABLE

AP2318

Pin Description

Pin Number		Pin Name	Function
DFN-3×3-8	SOIC-8		
1, 2	3, 4	V _{IN}	Input Voltage
3, 4	6	V _{OUT}	Output Voltage
5	7	ADJ/NC	Adjust Voltage/No Connection
6	8	GND	Ground
7	1, 5	NC	No connection
8	2	EN	On/Off control

Ordering Information

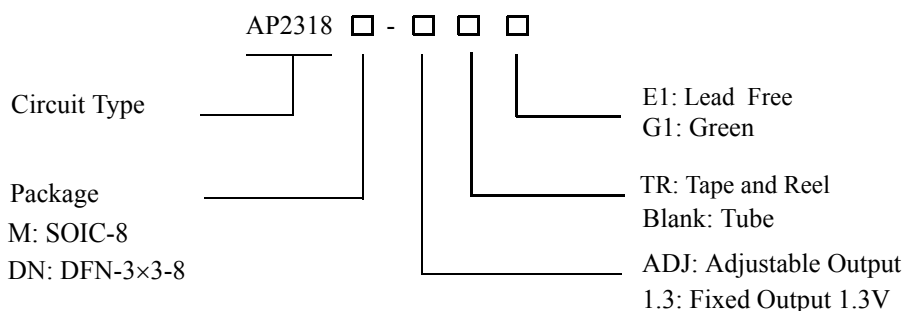

Package	Temperature Range	Part Number		Marking ID		Packing Type
		Lead Free	Green	Lead Free	Green	
SOIC-8	-40 to 125°C	AP2318M-ADJE1	AP2318M-ADJG1	2318M-ADJE1	2318M-ADJG1	Tube
		AP2318M-ADJTRE1	AP2318M-ADJTRG1	2318M-ADJE1	2318M-ADJG1	Tape & Reel
		AP2318M-1.3E1	AP2318M-1.3G1	2318M-1.3E1	2318M-1.3G1	Tube
		AP2318M-1.3TRE1	AP2318M-1.3TRG1	2318M-1.3E1	2318M-1.3G1	Tape & Reel
DFN-3×3-8	-40 to 125°C	AP2318DN-ADJTRE1	AP2318DN-ADJTRG1	F9E	B9E	Tape & Reel
		AP2318DN-1.3TRE1	AP2318DN-1.3TRG1	F9B	B9B	Tape & Reel

BCD Semiconductor's Pb-free products, as designated with "E1" suffix in the part number, are RoHS compliant. Products with "G1" suffix are available in green packages.

**600mA ULDO REGULATOR WITH ENABLE****AP2318****Absolute Maximum Ratings (Note 1)**

Parameter	Symbol	Value	Unit	
Input Voltage	V_{IN}	15	V	
Operating Junction Temperature	T_J	150	°C	
Storage Temperature Range	T_{STG}	-65 to 150	°C	
Lead Temperature (Soldering, 10sec)	T_{LEAD}	260	°C	
Thermal Resistance (Note 2)	θ_{JA}	SOIC-8	135	°C/W
		DFN-3×3-8	120	
ESD (Human Body Model)	ESD	3000	V	
ESD (Machine Model)	ESD	600	V	

Note 1: Stresses greater than those listed under "Absolute Maximum Ratings" may cause permanent damage to the device. These are stress ratings only, and functional operation of the device at these or any other conditions beyond those indicated under "Recommended Operating Conditions" is not implied. Exposure to "Absolute Maximum Ratings" for extended periods may affect device reliability.

Note 2: Absolute maximum ratings indicate limits beyond which damage to the component may occur. Electrical specifications do not apply when operating the device outside of its operating ratings. The maximum allowable power dissipation is a function of the maximum junction temperature, $T_J(\max)$, the junction-to-ambient thermal resistance, θ_{JA} , and the ambient temperature, T_A . The maximum allowable power dissipation at any ambient temperature is calculated using: $P_D(\max) = (T_J(\max) - T_A) / \theta_{JA}$. Exceeding the maximum allowable power dissipation will result in excessive die temperature, and the regulator will go into thermal shutdown.

Recommended Operating Conditions

Parameter	Symbol	Min	Max	Unit
Input Voltage	V_{IN}	2.5	12	V
Enable Voltage	V_{EN}		12	V
Operating Junction Temperature Range	T_J	-40	125	°C



600mA ULDO REGULATOR WITH ENABLE

AP2318

Electrical Characteristics

Operating Conditions: $2.5V \leq V_{IN} \leq 12V$, $C_{IN} = 1\mu F$, $C_{OUT} = 2.2\mu F$, $T_J = 25^\circ C$, unless otherwise specified. ($P \leq$ Maximum Power Dissipation). Limits appearing in **Boldface** type apply over the entire junction temperature range for operation of $-40^\circ C$ to $125^\circ C$.

Parameter	Symbol	Conditions	Min	Typ	Max	Unit
Reference Voltage	V_{REF}	AP2318-ADJ $I_{OUT} = 10mA$, $V_{IN} - V_{OUT} = 2V$, $T_J = 25^\circ C$ $10mA \leq I_{OUT} \leq 600mA$, $V_{OUT} + 2V \leq V_{IN} \leq 12V$	0.788 0.784	0.800 0.800	0.812 0.816	V
Output Voltage	V_{OUT}	$I_{OUT} = 10mA$, $V_{IN} = 2.5V$, $T_J = 25^\circ C$ $10mA \leq I_{OUT} \leq 600mA$, $2.5V \leq V_{IN} \leq 12V$	-1.5% -2%		1.5% 2%	V
Maximum Output Current	$I_{OUT(max)}$	$V_{IN} - V_{OUT} = 2V$	0.85	1.2		A
Line Regulation	V_{RLINE}	AP2318-ADJ $I_{OUT} = 10mA$, $V_{OUT} + 2V \leq V_{IN} \leq 12V$		1	6	mV
		$I_{OUT} = 10mA$, $2.5V \leq V_{IN} \leq 12V$		1	6	mV
Load Regulation	V_{RLOAD}	AP2318-ADJ $V_{IN} = V_{OUT} + 2V$, $10mA \leq I_{OUT} \leq 600mA$		1	10	mV
		$V_{IN} = 2.5V$, $10mA \leq I_{OUT} \leq 600mA$		1	10	mV
Dropout Voltage	V_{DROP}	$\Delta V_{OUT} (\Delta V_{REF}) = 1\%$, $I_{OUT} = 600mA$		0.35		V
Adjust Pin Current	I_{ADJ}			0.05	1	μA
Minimum Load Current	$I_{LOAD(min)}$	$V_{OUT} + 2V \leq V_{IN} \leq 12V$ (ADJ only)		1.7	5	mA
Quiescent Current	I_Q	$V_{IN} = V_{OUT} + 2V$, $I_{OUT} = 0mA$		250		μA
RMS Output Noise (% of V_{OUT})	V_{NOI}	$T_A = 25^\circ C$, $10Hz \leq f \leq 20kHz$		0.003		%
Thermal Shutdown Temperature				150		$^\circ C$
Thermal Shutdown Hysteresis				25		$^\circ C$
Enable Input Voltage	V_{EN}	Enable logic low			0.8	V
		Enable logic high	2.25			
Enable Input Current	I_{EN}	$V_{EN} = 2.25V$		5	15	μA
		$V_{EN} = 0.8V$			4	μA
Thermal Resistance, (Junction to Case)	θ_{JC}	DFN-3x3-8		15		$^\circ C/W$
		SOIC-8		24		



600mA ULDO REGULATOR WITH ENABLE

AP2318

Typical Performance Characteristics

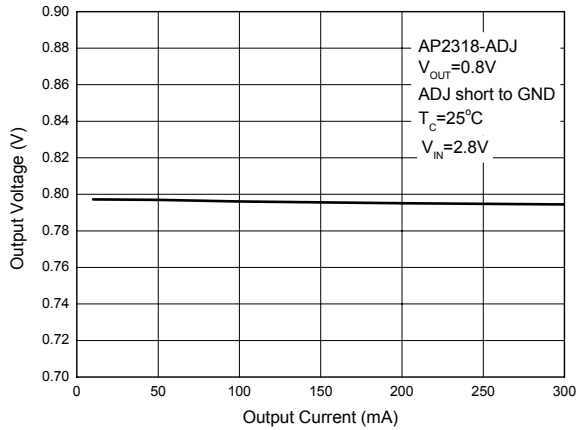

Figure 4. Output Voltage vs. Output Current
(Conditions: $V_{OUT}=0.8V$, ADJ Short to GND)

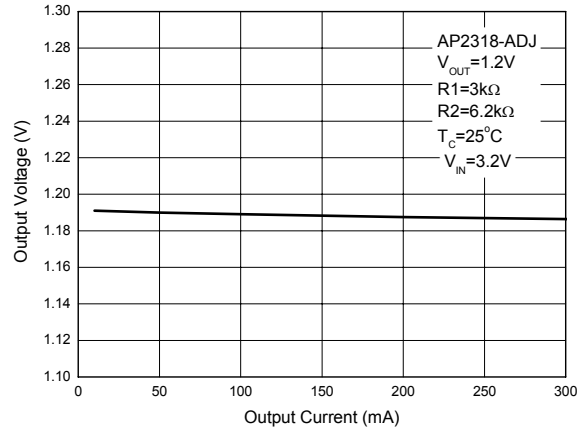

Figure 5. Output Voltage vs. Output Current
(Conditions: $V_{OUT}=1.2V$, $R1=3k\Omega$, $R2=6.2k\Omega$)

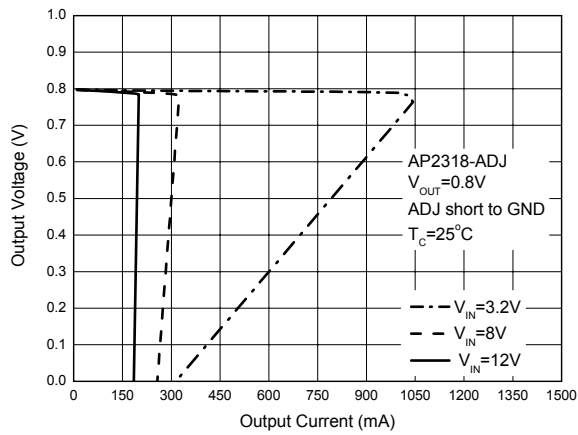

Figure 6. Output Voltage vs. Output Current
(Conditions: $V_{OUT}=0.8V$, ADJ Short to GND)

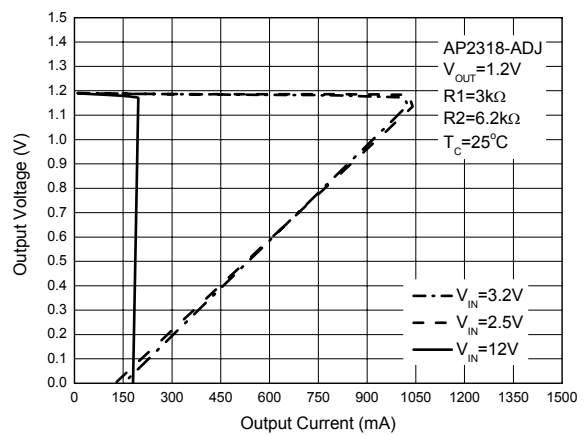

Figure 7. Output Voltage vs. Output Current
(Conditions: $V_{OUT}=1.2V$, $R1=3k\Omega$, $R2=6.2k\Omega$)



Typical Performance Characteristics (Continued)

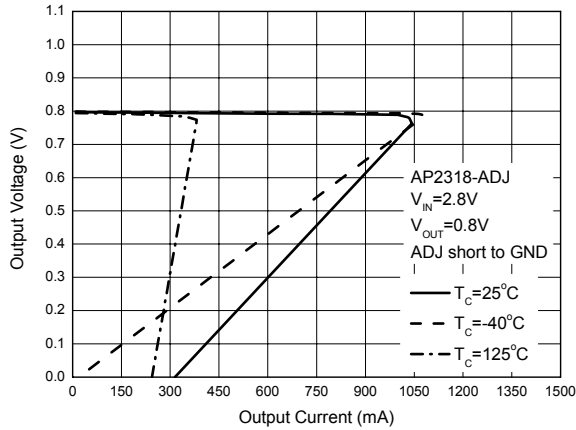

Figure 8. Output Voltage vs. Output Current
(Conditions: $V_{OUT}=0.8V$, ADJ Short to GND)

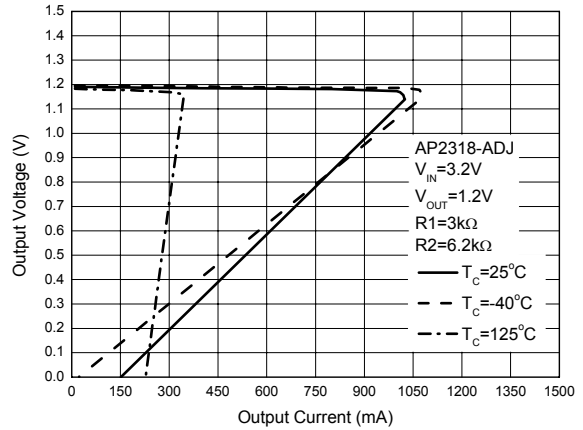

Figure 9. Output Voltage vs. Output Current
(Conditions: $V_{OUT}=1.2V$, $R1=3k\Omega$, $R2=6.2k\Omega$)

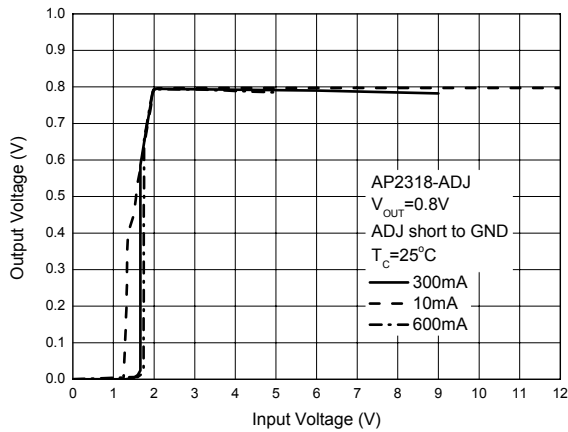

Figure 10. Output Voltage vs. Input Voltage
(Conditions: $V_{OUT}=0.8V$, ADJ Short to GND)

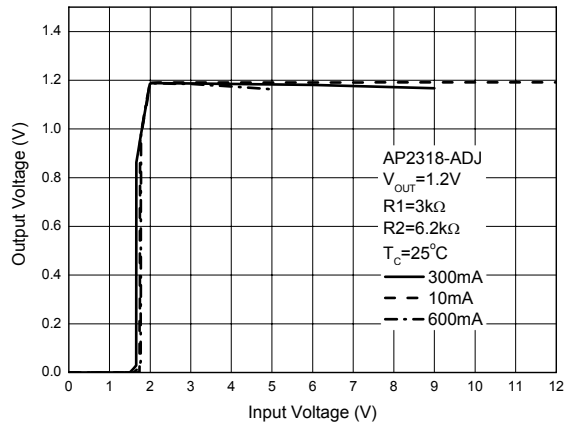

Figure 11. Output Voltage vs. Input Voltage
(Conditions: $V_{OUT}=1.2V$, $R1=3k\Omega$, $R2=6.2k\Omega$)



600mA ULDO REGULATOR WITH ENABLE

AP2318

Typical Performance Characteristics (Continued)

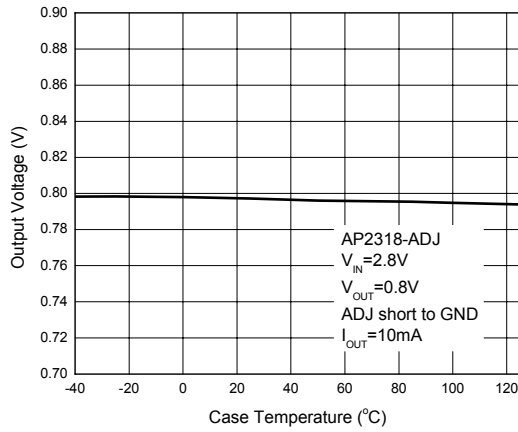

Figure 12. Output Voltage vs. Case Temperature (Conditions: $V_{OUT}=0.8V$, ADJ Short to GND)

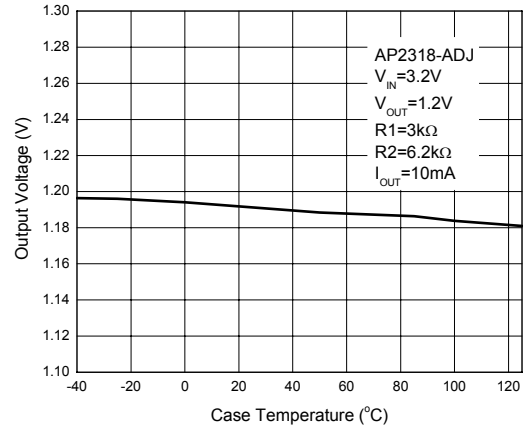

Figure 13. Output Voltage vs. Case Temperature (Conditions: $V_{OUT}=1.2V$, $R1=3k\Omega$, $R2=6.2k\Omega$)

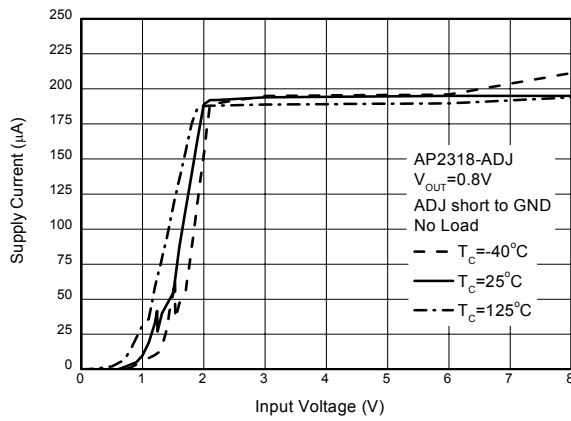

Figure 14. Supply Current vs. Input Voltage (Conditions: $V_{OUT}=0.8V$, ADJ Short to GND)

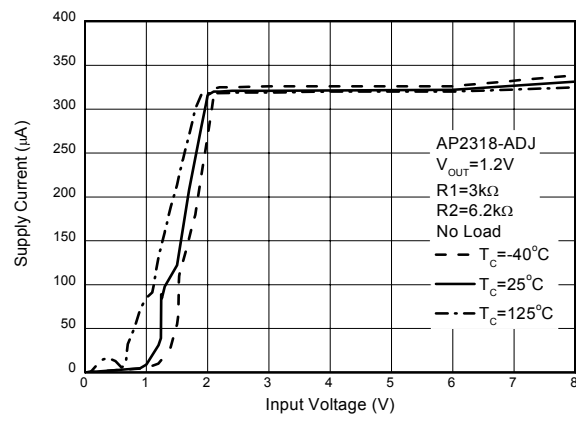

Figure 15. Supply Current vs. Input Voltage (Conditions: $V_{OUT}=1.2V$, $R1=3k\Omega$, $R2=6.2k\Omega$)



600mA ULDO REGULATOR WITH ENABLE

AP2318

Typical Performance Characteristics (Continued)

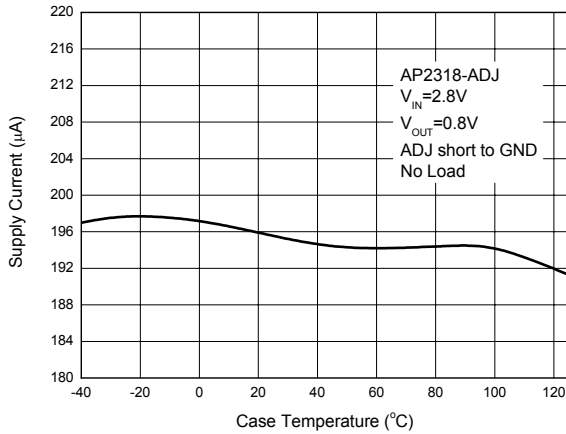

Figure 16. Supply Current vs. Case Temperature (Conditions: $V_{OUT}=0.8V$, ADJ Short to GND)

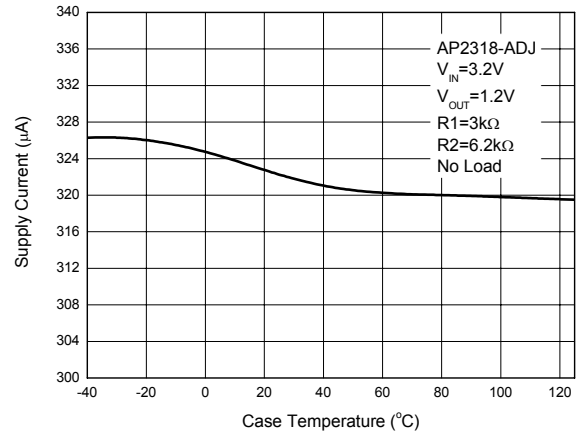

Figure 17. Supply current vs. Case Temperature (Conditions: $V_{OUT}=1.2V$, $R1=3k\Omega$, $R2=6.2k\Omega$)

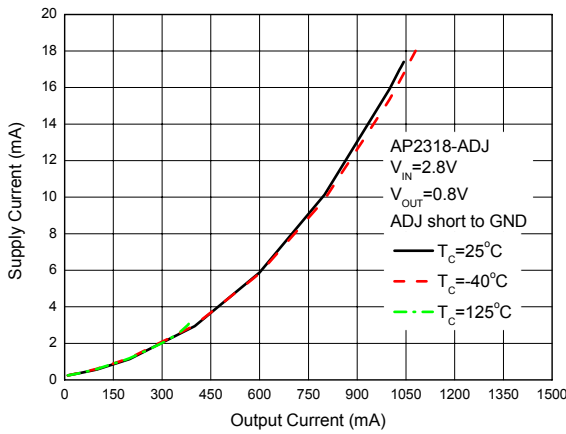

Figure 18. Supply Current vs. Output Current (Conditions: $V_{OUT}=0.8V$, ADJ Short to GND)

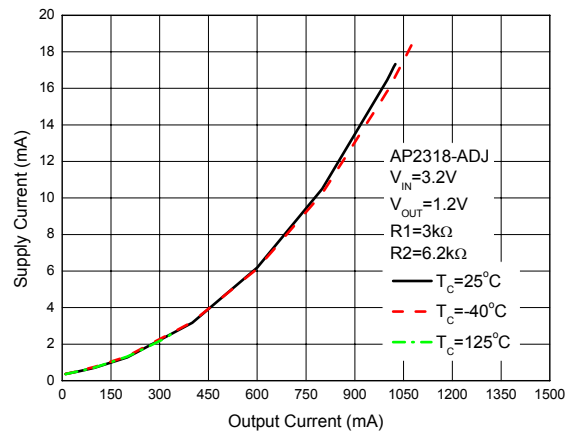

Figure 19. Supply Current vs. Output Current (Conditions: $V_{OUT}=1.2V$, $R1=3k\Omega$, $R2=6.2k\Omega$)

Typical Performance Characteristics (Continued)

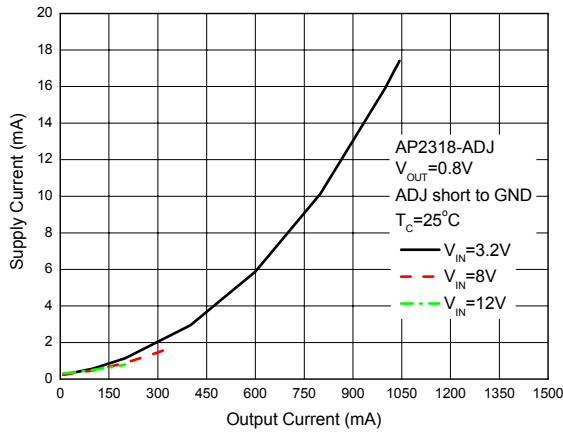

Figure 20. Supply Current vs. Output Current
 (Conditions: $V_{OUT}=0.8V$, ADJ Short to GND)

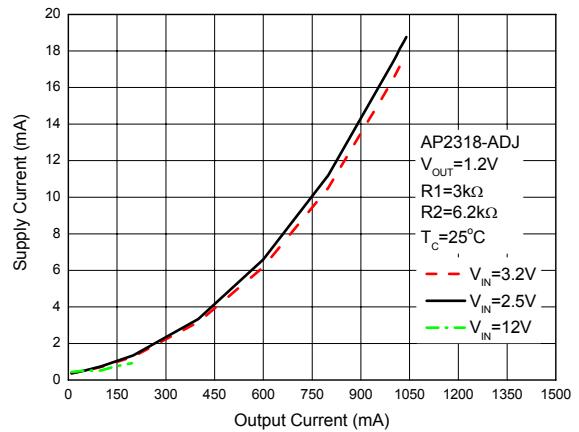

Figure 21. Supply Current vs. Output Current
 (Conditions: $V_{OUT}=1.2V$, $R1=3k\Omega$, $R2=6.2k\Omega$)

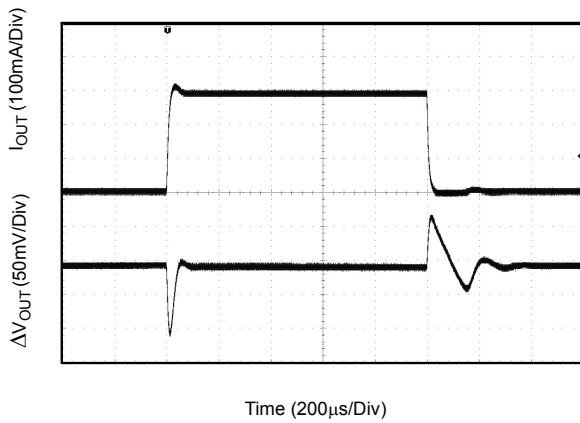

Figure 22. Load Transient Response
 (Conditions: $V_{IN}=2.5V$, $V_{OUT}=1.3V$, $I_{OUT}=1mA$ to $300mA$,
 $C_{IN}=1\mu F$, $C_{OUT}=2.2\mu F$)

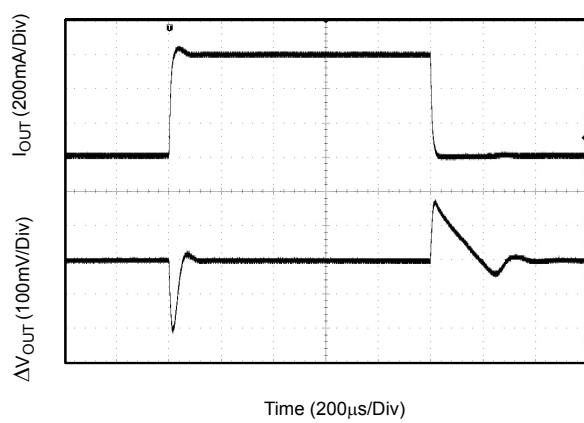

Figure 23. Load Transient Response
 (Conditions: $V_{IN}=2.5V$, $V_{OUT}=1.8V$, $I_{OUT}=1mA$ to $600mA$,
 $C_{IN}=1\mu F$, $C_{OUT}=2.2\mu F$)



600mA ULDO REGULATOR WITH ENABLE

AP2318

Typical Performance Characteristics (Continued)



Figure 24. Line Transient Response

(Conditions: $V_{IN}=2.5V$ to $5V$, $V_{OUT}=0.8V$, $I_{OUT}=10mA$, $C_{IN}=0\mu F$, $C_{OUT}=2.2\mu F$)



Figure 25. Line Transient Response

(Conditions: $V_{IN}=2.5V$ to $10V$, $V_{OUT}=0.8V$, $I_{OUT}=10mA$, $C_{IN}=0\mu F$, $C_{OUT}=2.2\mu F$)

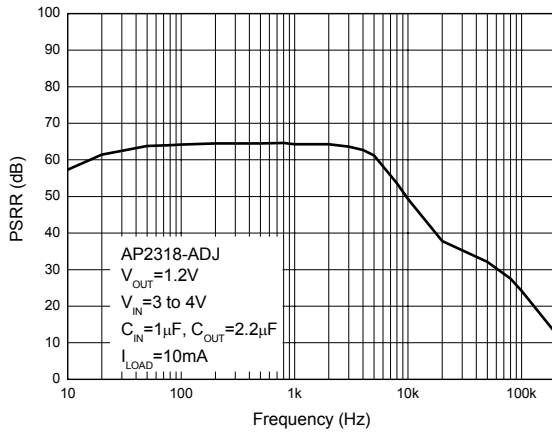

Figure 26. PSRR vs. Frequency

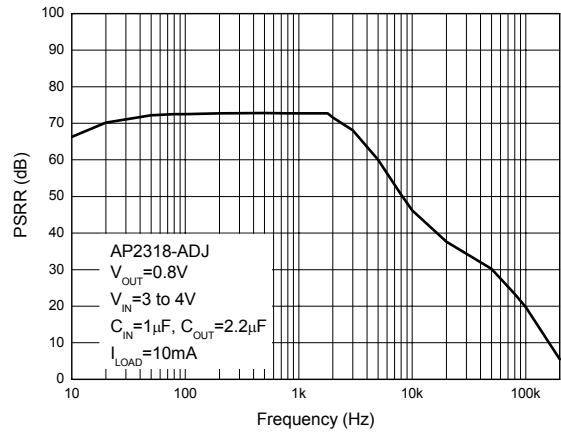

Figure 27. PSRR vs. Frequency



Typical Performance Characteristics (Continued)

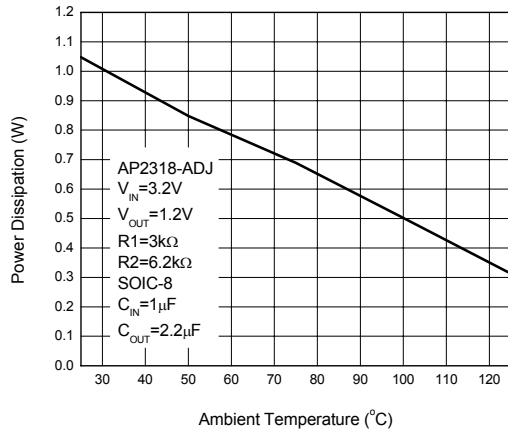

Figure 28. Power Dissipation vs. Ambient Temperature (Conditions: $V_{OUT}=1.2V$, $R1=3k\Omega$, $R2=6.2k\Omega$)

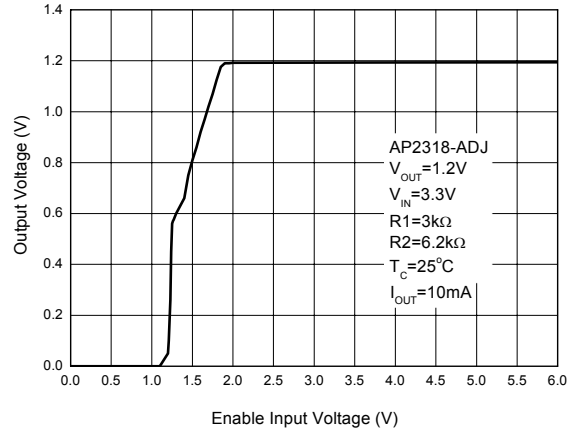

Figure 29. Output Voltage vs. Enable Input Voltage (Conditions: $V_{OUT}=1.2V$, $R1=3k\Omega$, $R2=6.2k\Omega$)

Typical Applications

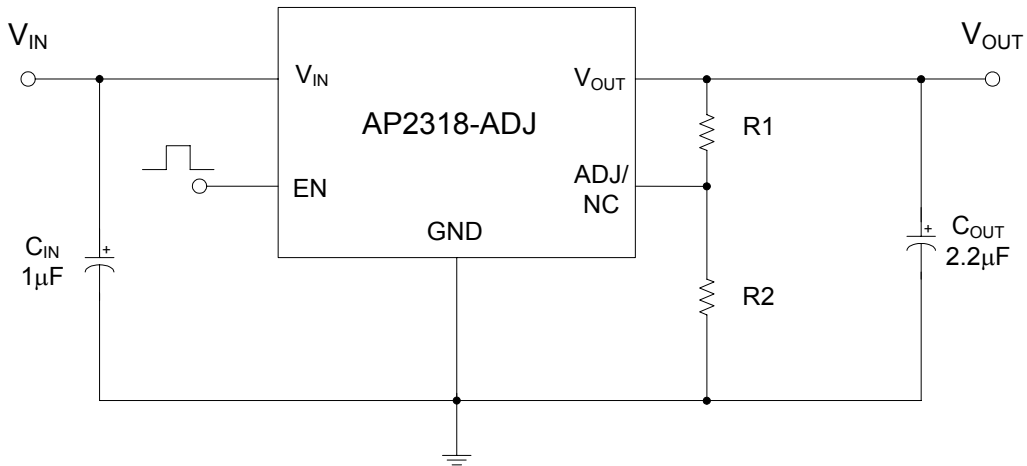

Figure 30. Typical Applications of AP2318 ADJ Version, $V_{OUT}=0.8*(R1+R2)/R2$

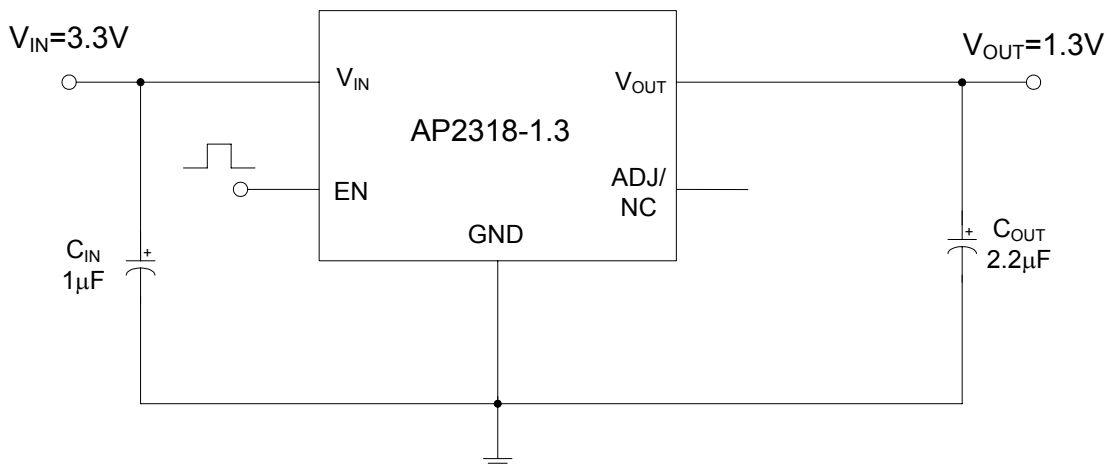

Figure 31. Typical Applications of AP2318 Fixed 1.3V Version, $V_{OUT}=1.3V$



600mA ULDO REGULATOR WITH ENABLE

AP2318

Mechanical Dimensions

SOIC-8

Unit: mm(inch)

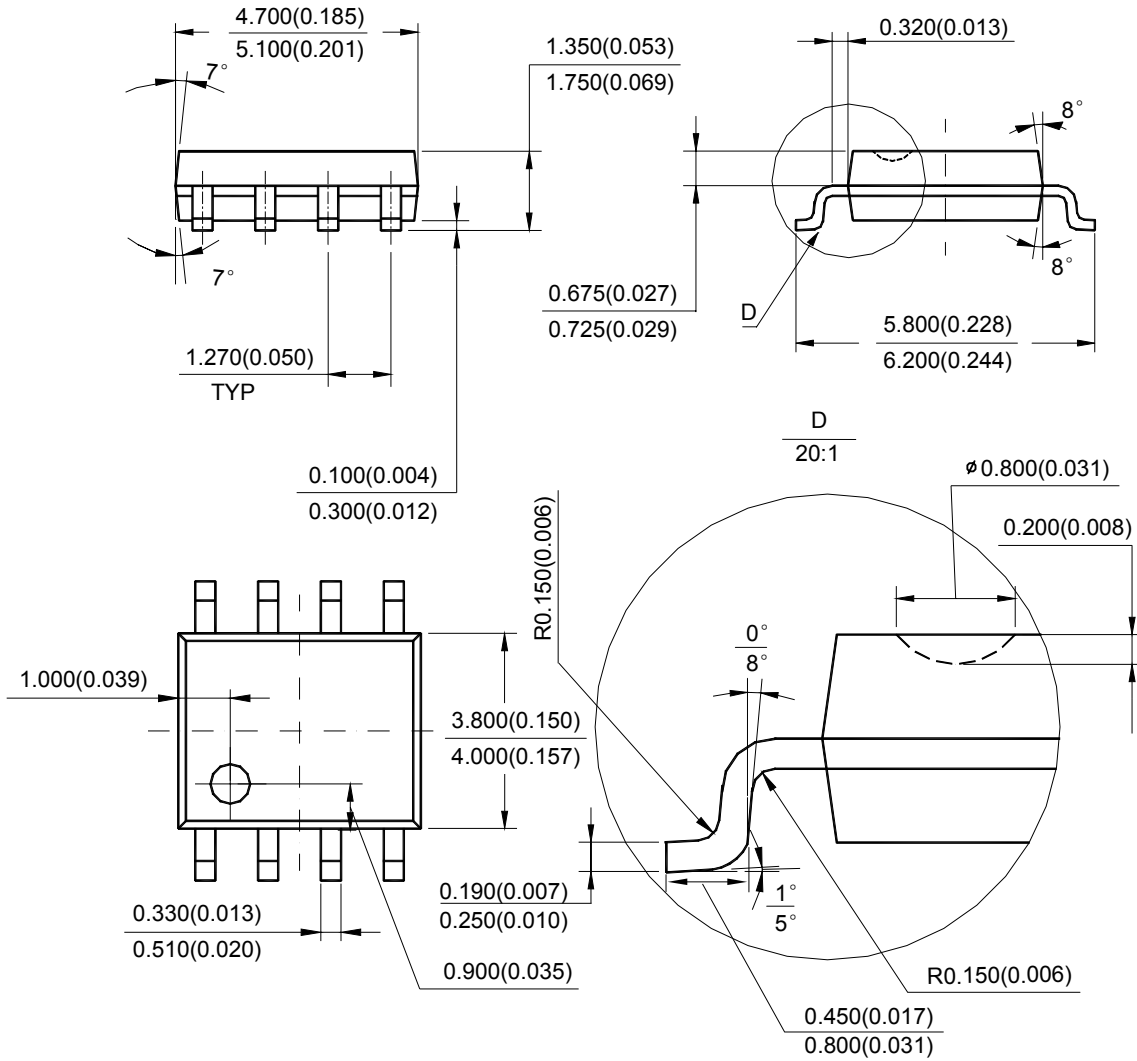

Note: Eject hole, oriented hole and mold mark is optional.



600mA ULDO REGULATOR WITH ENABLE

AP2318

Mechanical Dimensions (Continued)

DFN-3x3-8

Unit: mm(inch)

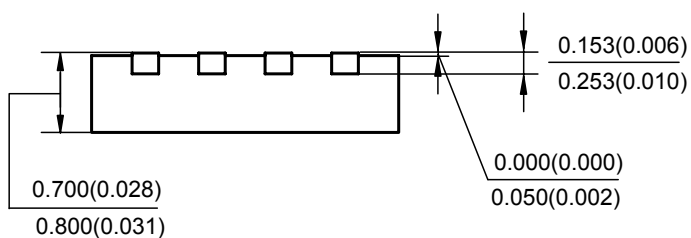
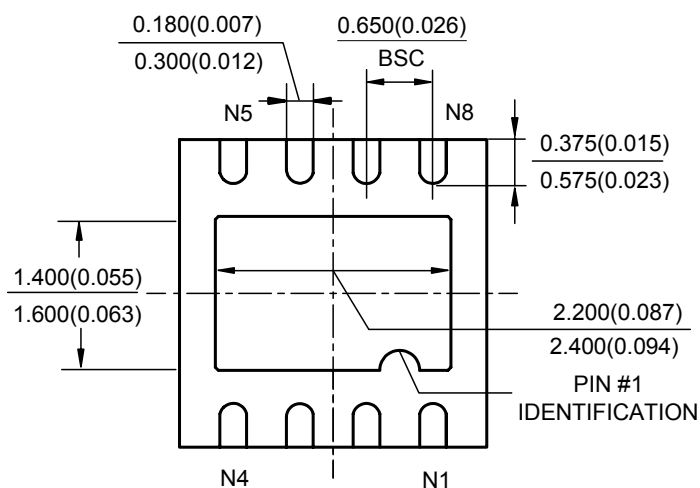
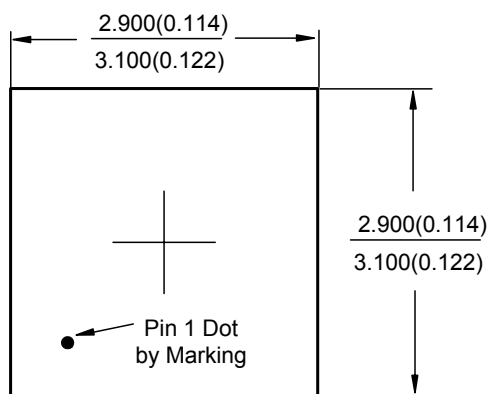



BCD Semiconductor Manufacturing Limited

<http://www.bcdsemi.com>

IMPORTANT NOTICE

BCD Semiconductor Manufacturing Limited reserves the right to make changes without further notice to any products or specifications herein. BCD Semiconductor Manufacturing Limited does not assume any responsibility for use of any its products for any particular purpose, nor does BCD Semiconductor Manufacturing Limited assume any liability arising out of the application or use of any its products or circuits. BCD Semiconductor Manufacturing Limited does not convey any license under its patent rights or other rights nor the rights of others.

MAIN SITE

- Headquarters

BCD Semiconductor Manufacturing Limited

No. 1600, Zi Xing Road, Shanghai ZiZhu Science-based Industrial Park, 200241, China
Tel: +86-21-24162266, Fax: +86-21-24162277

- Wafer Fab

Shanghai SIM-BCD Semiconductor Manufacturing Co., Ltd.

800 Yi Shan Road, Shanghai 200233, China
Tel: +86-21-6485 1491, Fax: +86-21-5450 0008

REGIONAL SALES OFFICE

Shenzhen Office

Shanghai SIM-BCD Semiconductor Manufacturing Co., Ltd., Shenzhen Office

Unit A Room 1203, Skyworth Bldg., Gaoxin Ave. 1.S., Nanshan District, Shenzhen, China
Tel: +86-755-8826 7951
Fax: +86-755-8826 7865

Taiwan Office

BCD Semiconductor (Taiwan) Company Limited

4F, 298-1, Rui Guang Road, Nei-Hu District, Taipei, Taiwan
Tel: +886-2-2656 2808
Fax: +886-2-2656 2806

USA Office

BCD Semiconductor Corp.

30920 Huntwood Ave. Hayward, CA 94544, USA
Tel : +1-510-324-2988
Fax: +1-510-324-2788